



The 5-Phase Stepping Driver

PMM-MD-53030-10

PMM-MD-53031-10

DC 24 V/36 V

Micro-step (500 x 1 to 250 divisions)

● Applicable motors

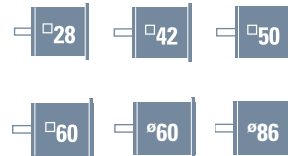

Characteristics

● Micro-step function available

Smooth operation without vibration at low speeds can be realized.

● Flexible

Various stepping motors of small to large capacities can be driven without adjustment for wide range uses.

● Downsizing

Dedicated HIC is mounted to improve parts consolidation and reliability.

● The 2-type interface circuit specifications

Photocoupler input type : PMM-MD-53030-10

C-MOS input type : PMM-MD-53031-10

Built-in function

● Step angle setting function

Sixteen resolutions ranging from 1- to 250-division can be set for the basic step angle of stepping motor by using the rotary switch.

● Step angle selection function

The 2-type micro-step resolutions can be selected using the external input signal.

● Pulse input system selection function

Either "Pulse and direction mode" or "2-input mode" can be selected, using a dipswitch. Resolution setting function.

● Power down function

The stepping motor power can be turned OFF by the external input signal.

PM driver specifications

Item		PMM-MD-53030-10	PMM-MD-53031-10	
Input source	For main power source	DC24V/36V±10%		
	For control power source	-	DC5V±5%	
Source current	For main power source	3A		
	For control power source	-	0.15A	
Basic specifications	Environment	Operating ambient temperature	0 to +50 °C	
		Conservation temperature	- 20 to + 70 °C	
		Operating ambient humidity	35 to 85 % RH (no condensation)	
		Conservation humidity	10 to 90 % RH (no condensation)	
		Vibration resistance	Tested under the following conditions: Frequency range: 10 to 55 Hz, 0.5 G along the X, Y, and Z axes for 2 hours	
		Impact resistance	No abnormality for the NDS-C-0110 Standard, Section 3.2.2, Division "C".	
		Withstand voltage	No abnormality against an AC 500 V application between the power input terminal and the cabinet for one minute.	
		Insulation resistance	Minimum 10 MΩ when applying the DC 500 V Megger between the power input terminal and the cabinet.	
		Mass(Weight)	0.31kg (0.68 lbs)	
Function	Selection function	Automatic current reduction, pulse input system, step angle, and power source specifications		
I/O signals	Command pulse input signal	Photocoupler input system, input resistance 330 Ω Input signal voltage: "H" level: 4.0 to 5.5 V "L" level: 0 to 0.5 V Maximum input frequency: 400 kpulses/s	C-MOS input Input signal voltage: "H" level: 4.0 to 5.5 V "L" level: 0 to 0.5 V Maximum input frequency: 400 kpulses/s	
	Power down input signal	Photocoupler input system, input resistance 330 Ω Input signal voltage: "H" level: 4.0 to 5.5 V "L" level: 0 to 0.5 V	C-MOS input Input signal voltage: "H" level: 4.0 to 5.5 V "L" level: 0 to 0.5 V	
	Step angle selection input signal	Photocoupler input system, input resistance 330 Ω Input signal voltage: "H" level: 4.0 to 5.5 V "L" level: 0 to 0.5 V	C-MOS input Input signal voltage: "H" level: 4.0 to 5.5 V "L" level: 0 to 0.5 V	
	Phase origin monitor output signal	Open collector output by photocoupler (turns ON at the phase origin) Output standard Vceo: Maximum 30 V, Ic: Maximum 5 mA	Open collector output by transistor (turns ON at the phase origin) Output standard Vceo: Maximum 30 V, Ic: Maximum 5 mA	

Standard combined stepping motor

Stepping motor dimensions	Stepping motor model number		Holding torque N·m(oz·in)	Rotor inertia ×10 ⁻⁴ kg·m ² (oz·in ²)	Mass(Weight) kg(lbs)	Page
	Single shaft	Double shaft				
□28mm	103H3505-7040	103H3505-7010	0.026(3.68)	0.009(0.05)	0.11(0.24)	Page 299
	103H3515-7040	103H3515-7010	0.052(7.36)	0.016(0.09)	0.2(0.44)	
□42mm	103H5505-7040	103H5505-7010	0.127(17.98)	0.03(0.16)	0.23(0.51)	Page 301
	103H5508-7040	103H5508-7010	0.176(24.92)	0.053(0.29)	0.28(0.62)	
	103H5510-7040	103H5510-7010	0.255(36.11)	0.065(0.36)	0.37(0.82)	
□50mm	103H6500-7041	103H6500-7011	0.235(33.28)	0.057(0.31)	0.38(0.84)	Page 303
	103H6501-7041	103H6501-7011	0.39(55.23)	0.105(0.57)	0.44(0.97)	
□60mm	103H7851-7051	103H7851-7021	0.65(92.0)	0.275(1.50)	0.6(1.32)	Page 305
	103H7852-7051	103H7852-7021	0.98(138.8)	0.4(2.19)	0.78(1.72)	
	103H7853-7051	103H7853-7021	1.86(263.4)	0.84(4.59)	1.36(3.00)	
ø60mm	103H7521-7051	103H7521-7021	0.461(65.3)	0.148(0.81)	0.51(1.12)	Page 307
	103H7522-7051	103H7522-7021	0.735(104.1)	0.18(0.98)	0.6(1.32)	
	103H7523-7051	103H7523-7021	1.568(222.0)	0.423(2.31)	1.1(2.43)	
ø86mm	103H8581-7041	103H8581-7011	2.06(291.7)	1.45(7.93)	1.5(3.31)	Page 309
	103H8582-7041	103H8582-7011	4.02(569.3)	2.9(15.86)	2.5(5.51)	
	103H8583-7041	103H8583-7011	6.17(873.7)	4.4(24.06)	3.5(7.72)	

- For the general specifications and dimensions of each stepping motor, refer to the reference pages.

Operation, connection, and function

● Each section name of the PM driver

PMM-MD-53030-10 (photo coupler input system)

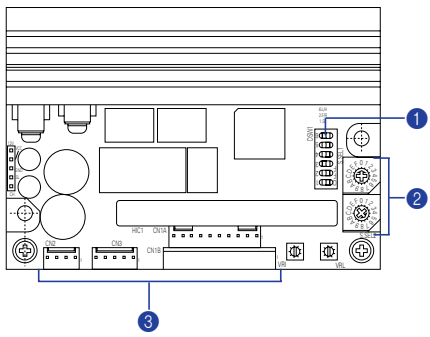

- ① Function selection dials (SL, F/R, and L/H)
..... Functions can be selected according to specifications.
- ② Step angle selection rotary switch (S. SEL1 and S. SEL2)
..... The basic step angle of stepping motor can be divided to maximum 250 divisions.
- ③ Connector (CN1A, CN2 and CN3)
..... Connects the I/O signal, the DC power source, and the stepping motor power cable.

PMM-MD-53031-10 (CMOS input system)

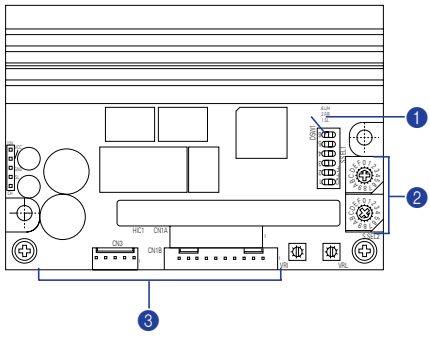

- ① Function selection dials (SL, F/R, and L/H)
..... Functions can be selected according to specifications.
- ② Step angle selection rotary switch (S. SEL1 and S. SEL2)
..... The basic step angle of stepping motor can be divided to maximum 250 divisions.
- ③ Connector (CN1B and CN3)
..... Connects the I/O signal, the DC power source, and the stepping motor power cable.

● External wiring diagram

PMM-MD-53030-10 (photo coupler input system)

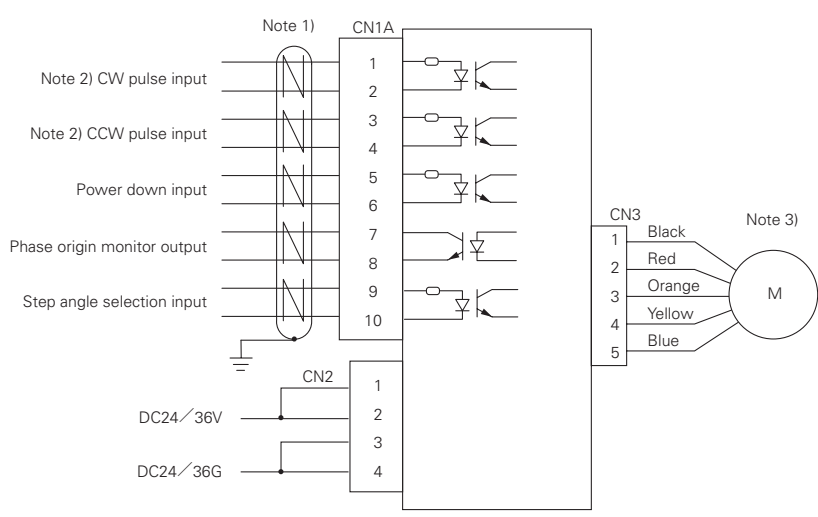

Note 1) Use shielded twisted-pair cables.
 Note 2) Either "2-input mode (CW and CCW)" or "Pulse and direction mode (CK and U/D)" can be selected by using the function selection switch F/R
 Note 3) Refer to the following table when connecting the 103H35 □ 5 or 103H785 □ type stepping motor:

Product	Connector pin number				
PM driver connector	1	2	3	4	5
Stepping motor connector	1	4	3	2	5

Operation, connection, and function

PMM-MD-53031-10 (CMOS input system)

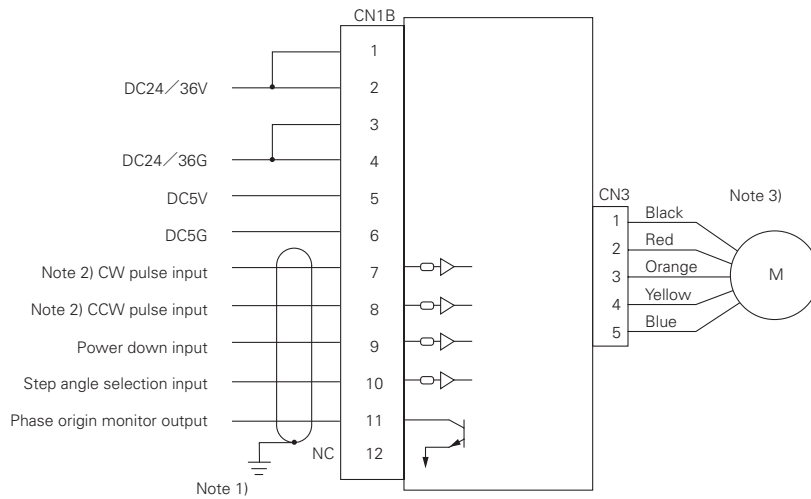

- Note 1) Use a shielded cable.
- Note 2) Either "2-input mode (CW and CCW)" or "Pulse and direction mode (CK and U/D)" can be selected by using the function selection switch F/R
- Note 3) Refer to the following table when connecting the 103H35 □ 5 or 103H785 □ type stepping motor:

Product	Connector pin number				
PM driver connector	1	2	3	4	5
Stepping motor connector	1	4	3	2	5

● Function selection dipswitch ①

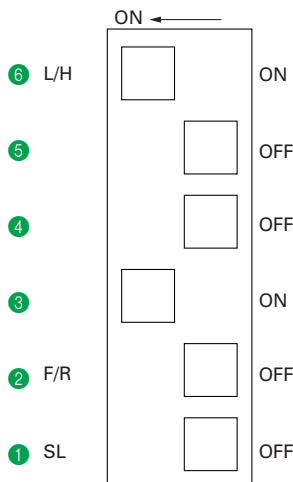

① SL (automatic current reduction selection)
Automatic current reduction function is selected.

SL	Automatic current reduction
ON	100% of current rating when stopped
OFF	Approx. 50% of current rating when stopped

② F/R (pulse input system selection)
A pulse input system is selected.

F/R	Pulse input system
ON	Pulse and direction mode (CK and U/D)
OFF	2-input mode (CW and CCW)

Note 1) The temperature increase in the motor driver can be controlled by setting SL to OFF (approx. 50% of the rated current).

Note 2) The output torque when SL is OFF (approx. 50% of the rated current) is approx. 50% of that when SL is ON (100% of the rated current).

③ ④ ⑤ Do not change the third, fourth, and fifth dipswitch settings (Note).

⑥ L/H (power specification selection)
The specification is changed from DC 24 V to DC 36 V.

L/H	Power specification
ON	DC 24 V specified
OFF	DC 36 V specified

- The function selection dipswitches specifications are common for PMM-MD-53030-10 and PMM-MD-53031-10.
- Settings at the shipment are shown above.
- Turn OFF the PM driver power before changing switch settings to change the function selection dipswitch settings.

Operation, connection, and function

● Step angle selection switch (S. SEL1 and S. SEL2)---②

Operation current value of stepping motor can be selected.

Scale	0	1	2	3	4	5	6	7
Number of divisions	1	2	2.5	4	5	8	10	20
Scale	8	9	A	B	C	D	E	F
Number of divisions	25	40	50	80	100	125	200	250

- "0" and "6" are set for S. SEL1 and S. SEL2 at the shipment, respectively.

● I/O signal function---③

Signal name (Abbreviation)	Pin number(CN1)		Function
	Photo coupler input system	CMOS input system	
Pulse input (CW)	1	7	When using "2-input mode"
	2		Drive pulse for the CW direction rotation is input.
Pulse column input (CK)	1	7	When using "Pulse and direction mode"
	2		Drive pulse train for the stepping motor rotation is input.
Pulse input (CCW)	3	8	When using "2-input mode"
	4		Drive pulse for the CCW direction rotation is input.
Rotation direction input (U/D)	3	8	The rotation direction signal of stepping motor is input for the "Pulse and direction mode".
	4		Internal photocoupler ON ("H" level for the C-MOS type) CW direction Internal photocoupler OFF ("L" level for the C-MOS type) CCW direction
Power down input (PD)	5	9	Inputting the PD signal cuts OFF the current flowing through the stepping motor (turns OFF the power).
	6		PC type: Internal photocoupler (ON) PD function enabled C-MOS type: "L" level input PD function enabled
Step angle selection input (S.SEL)	9	10	Resolution setting function (S. SEL1 and S. SEL2) can be selected by the S. SEL input signal.
	10		Internal photocoupler ON ("H" level for the C-MOS type) S. SEL1 setting enabled Internal photocoupler OFF ("L" level for the C-MOS type) S. SEL2 setting enabled
Phase origin monitor output (MON)	7	11	It is turned ON when the excitation phase is at the origin (in the state when the power is turned ON)
	8		It is turned ON once per 10 pulses during the full-step. It is turned ON once per 20 pulses during the half-step.

- The PC type and the C-MOS type in the table indicate "PMM-MD-53030-10" and "PMM-MD-53031-10", respectively.
- The CW direction of stepping motor means the clockwise direction rotation as viewed from the output shaft side (flange side). The CCW direction means the counterclockwise direction rotation as viewed from the output shaft side (flange side).

● Connectors to be used

PMM-MD-53030-10 (Photo coupler input system)

PM driver side		Applicable connector model number	Manufacturer
Used for	Model number		
I/O signals (CN1)	5045-10AG	Applicable housing:5051-10 Applicable contact:2759PBGL	Molex Japan
DC power source (CN2)	5045-04A	Applicable housing:5051-04 Applicable contact:5159PBTL	Molex Japan
Stepping motor (CN3)	5045-05A	Applicable housing:5051-05 Applicable contact:5159PBTL	Molex Japan

- The applicable connectors should be either prepared by the user or ordered from the optional connector set or connector cables (refer to Option in page 251).

PMM-MD-53031-10 (CMOS input system)

PM driver side		Applicable connector model number	Manufacturer
Used for	Model number		
I/O signal and DC power source (CN1B)	5045-12AG	Applicable housing:5051-12 Applicable contact:2759PBGL	Molex Japan
Stepping motor (CN3)	5045-05A	Applicable housing:5051-05 Applicable contact:5159PBTL	Molex Japan

- The applicable connectors should be either prepared by the user or ordered from the optional connector set or connector cables (refer to Option in page 252).

Operation, connection, and function

PMM-MD-53030-10 (Photo coupler input system)

● Input circuit configuration (CW and CCW)

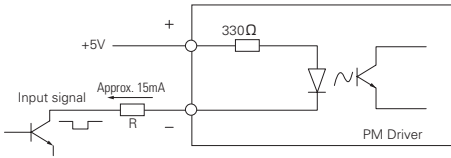

- Pulse duty is 50% MAX.
- When the peak value of the input signal is 5V, the external limit resistance R is 0 Ω. If the peak value exceeds 5V, set the input current to approx. 15mA using the external limit resistance R.

Input signal specifications

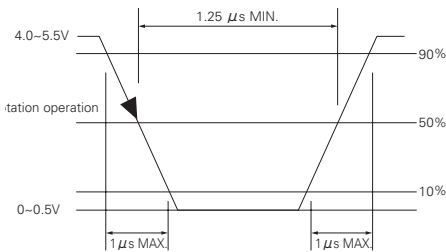

Timing of the command pulse

● 2-input mode (CW and CCW)

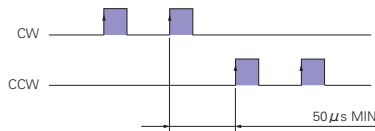

- The internal photocoupler turns ON at [H], and the internal circuit (stepping motor) operates at the leading edge of the photocoupler "ON".
- When applying the pulse to CW, set the internal photocoupler on the CCW side to "OFF".
- When applying the pulse to CCW, set the internal photocoupler on the CW side to "OFF".

● Pulse and direction mode (CK and U/D)

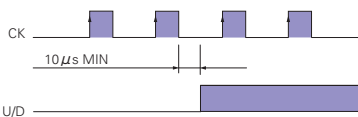

- The internal photocoupler turns ON at [H], and the internal circuit (stepping motor) operates at the leading edge of the photocoupler "ON".
- Perform the U/D input signal switchover when the CK-side internal photocoupler is set to "OFF".

PMM-MD-53031-10 (CMOS input system)

● Input circuit configuration (CW and CCW)

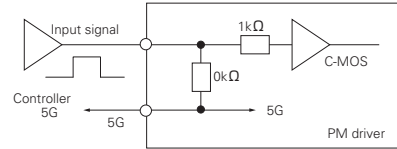

- Pulse duty is 50% MAX.

Input signal specifications

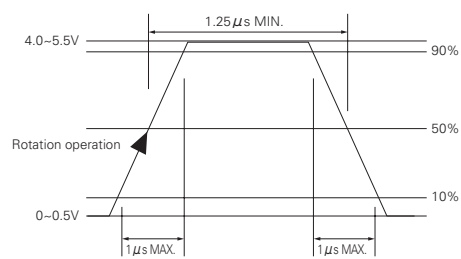

Timing of the command pulse

● 2-input mode (CW and CCW)

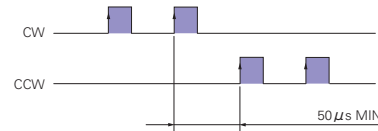

- The "H" level input is set at [H], and the internal circuit (stepping motor) operates at the leading edge of the "H" level.
- When applying the pulse to CW, set the CCW side input level to the "L" level.
- When applying the pulse to CCW, set the CW side input level to the "L" level.

● Pulse and direction mode (CK and U/D)

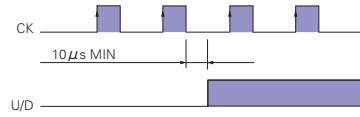

- The "H" level input is set at [H], and the internal circuit (stepping motor) operates at the leading edge of the "H" level of the CK-side input pulse.
- Perform the U/D input signal switchover when the CK-side input level is at the "L" level.

PMAFPA1S6A01

PMAFPA1S6B01

PMM-MA-50034

PMM-MA-50064

PMM-BA-5603-5643

PMM-BA-5604-5644

PMDPB1S6P01

PMDPC1S3P01

PMM-MD-53030-53031

PMM-BD-53130-53131

PMDPD1S1P01

PMDPA1C3P50

Operation, connection, and function

PMM-MD-53030-10 (Photo coupler input system)

● Input circuit configuration (PD and S. SEL)

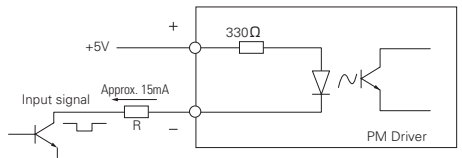

- When the peak value of the input signal is 5V, the external limit resistance R is 0 Ω. If the peak value exceeds 5V, set the input current to approx. 15mA using the external limit resistance R.

● Output circuit configuration (MON)

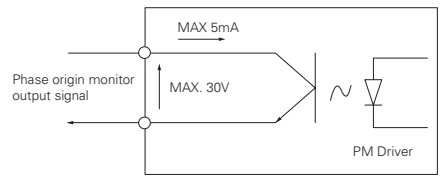

- Phase origin monitor output signal
 Contact type : Open collector output by the photocoupler
 Contact capacity : DC 30 V, 5 mA MAX.

Timing of the MON output (when 1-division is specified)

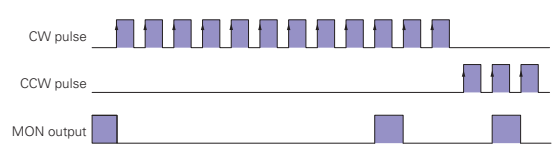

- The internal photocoupler or the transistor turns "ON" at ■.

PMM-MD-53031-10 (CMOS input system)

● Input circuit configuration (PD and S. SEL)

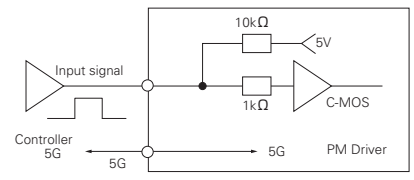

- When the peak value of the input signal is 5V, the external limit resistance R is 0 Ω. If the peak value exceeds 5V, set the input current to approx. 15mA using the external limit resistance R.

● Output circuit configuration (MON)

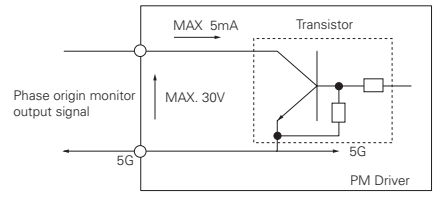

- Phase origin monitor output signal
 Contact type : Open collector output by the transistor
 Contact capacity : DC 30 V, 5 mA MAX.

Timing of the MON output (when 1-division is specified)

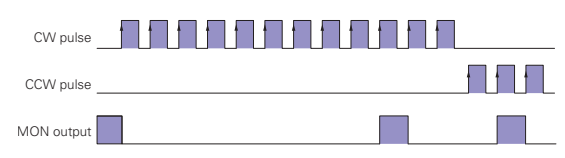

- The internal photocoupler or the transistor turns "ON" at ■.

Dimensions [Unit:mm(inch)]

PMM-MD-53030-10 (Photo coupler input system)

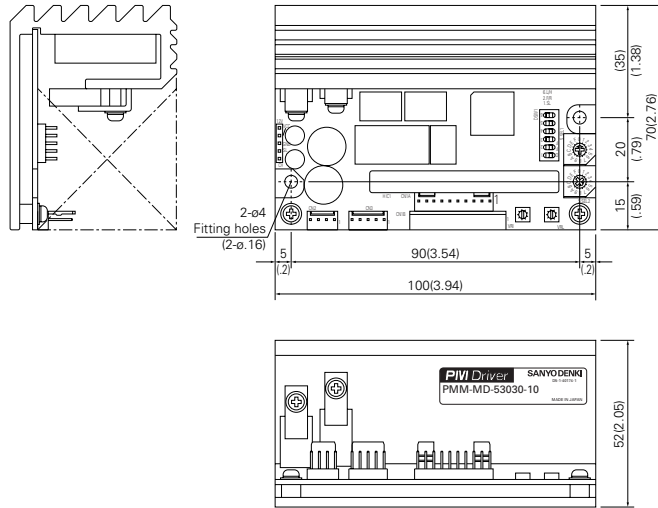

PMM-MD-53031-10 (CMOS input system)

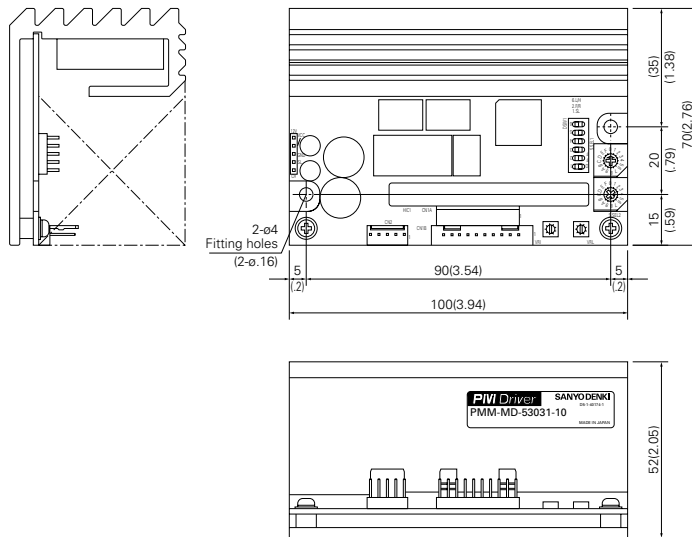

Installation direction and position

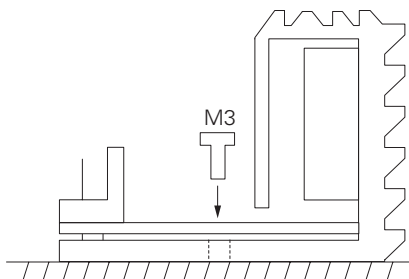

- Install the PM driver vertically.
- As shown in the figure, fix the PM driver by using the M3 screws through two fitting holes (φ4) on the bottom surface of PM driver (no fitting metals are necessary).

PMA PA1S6A01

PMA PA1S6B01

PMM-MA-50034

PMM-MA-50064

PMM-BA-5603-5643

PMM-BA-5604-5644

PMDPB1S6P01

PMDPC1S3P01

PMM-MD-53030-53031

PMM-BD-53130-53131

PMDPD1S1P01

PMDPA1C3P50

Pulse rate-torque characteristics/pulse rate-source current characteristics

●103H3505-70 □□ :24V

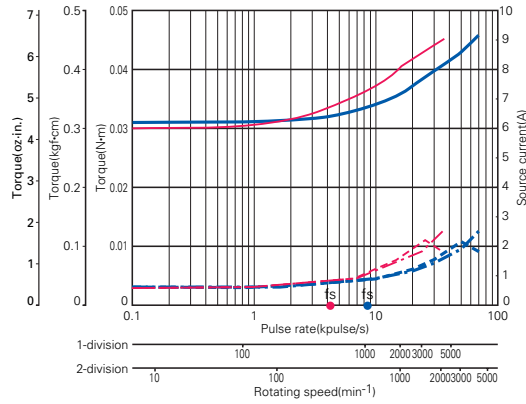

Source voltage:DC24V-Operating current: 0.75A/phase
 — Pull-out torque($J_{L1}=0.33 \times 10^{-4} \text{kg}\cdot\text{m}^2$ [1.80 oz·in²] Use the rubber coupling)
 - - - Source current($T_L=\text{MAX}$) - - - Source current($T_L=0$)
 fs:No load maximum starting pulse rate
 ■ Full step ■ Half step

●103H3505-70 □□ :36V

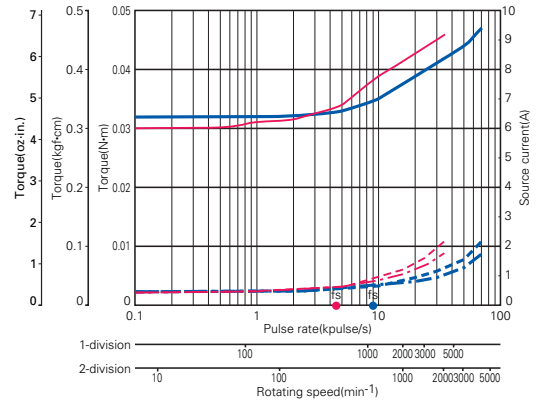

Source voltage:DC36V-Operating current: 0.75A/phase
 — Pull-out torque($J_{L1}=0.33 \times 10^{-4} \text{kg}\cdot\text{m}^2$ [1.80 oz·in²] Use the rubber coupling)
 - - - Source current($T_L=\text{MAX}$) - - - Source current($T_L=0$)
 fs:No load maximum starting pulse rate
 ■ Full step ■ Half step

●103H3515-70 □□ :24V

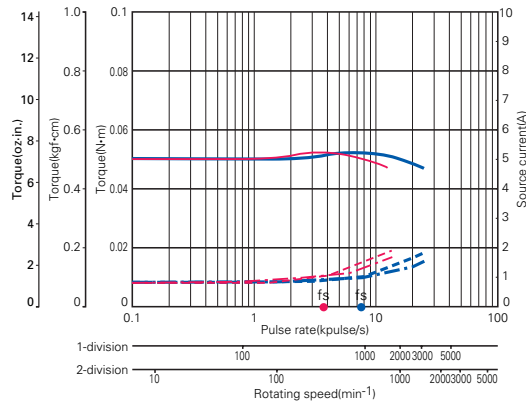

Source voltage:DC24V-Operating current: 0.75A/phase
 — Pull-out torque($J_{L1}=0.33 \times 10^{-4} \text{kg}\cdot\text{m}^2$ [1.80 oz·in²] Use the rubber coupling)
 - - - Source current($T_L=\text{MAX}$) - - - Source current($T_L=0$)
 fs:No load maximum starting pulse rate
 ■ Full step ■ Half step

●103H3515-70 □□ :36V

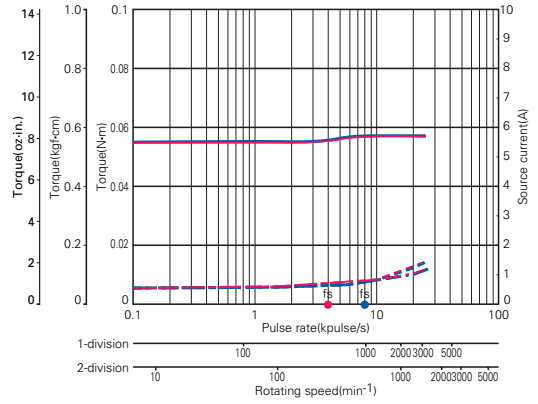

Source voltage:DC36V-Operating current: 0.75A/phase
 — Pull-out torque($J_{L1}=0.33 \times 10^{-4} \text{kg}\cdot\text{m}^2$ [1.80 oz·in²] Use the rubber coupling)
 - - - Source current($T_L=\text{MAX}$) - - - Source current($T_L=0$)
 fs:No load maximum starting pulse rate
 ■ Full step ■ Half step

●103H5505-70 □□ :24V

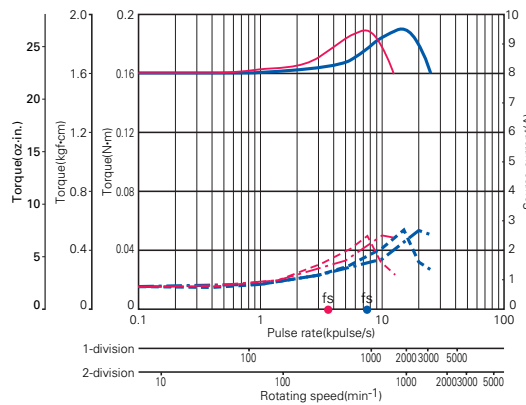

Source voltage:DC24V-Operating current: 0.75A/phase
 — Pull-out torque($J_{L1}=0.33 \times 10^{-4} \text{kg}\cdot\text{m}^2$ [1.80 oz·in²] Use the rubber coupling)
 - - - Source current($T_L=\text{MAX}$) - - - Source current($T_L=0$)
 fs:No load maximum starting pulse rate
 ■ Full step ■ Half step

●103H5505-70 □□ :36V

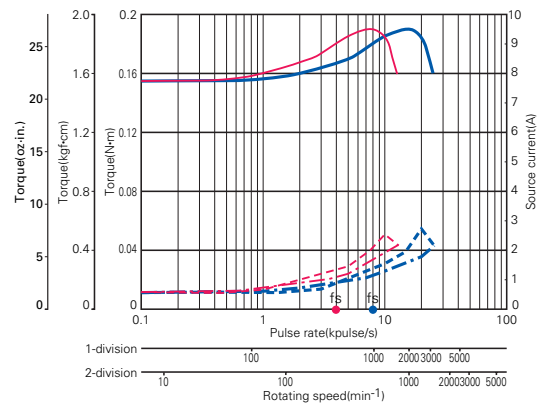

Source voltage:DC36V-Operating current: 0.75A/phase
 — Pull-out torque($J_{L1}=0.33 \times 10^{-4} \text{kg}\cdot\text{m}^2$ [1.80 oz·in²] Use the rubber coupling)
 - - - Source current($T_L=\text{MAX}$) - - - Source current($T_L=0$)
 fs:No load maximum starting pulse rate
 ■ Full step ■ Half step

Pulse rate-torque characteristics/pulse rate-source current characteristics

●103H5508-70 □□:24V

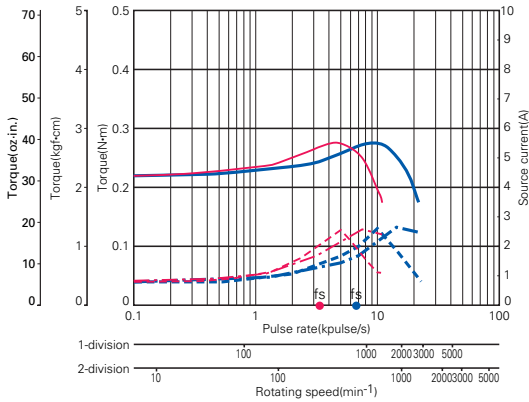

Source voltage:DC24V-Operating current: 0.75A/phase
 — Pull-out torque(J_{L1}=0.94×10⁻⁴kg-m²[5.14 oz-in²]) Use the rubber coupling)
 - - - Source current(T_L=MAX) - - - Source current(T_L=0)
 fs:No load maximum starting pulse rate
 ■ Full step ■ Half step

●103H5508-70 □□:36V

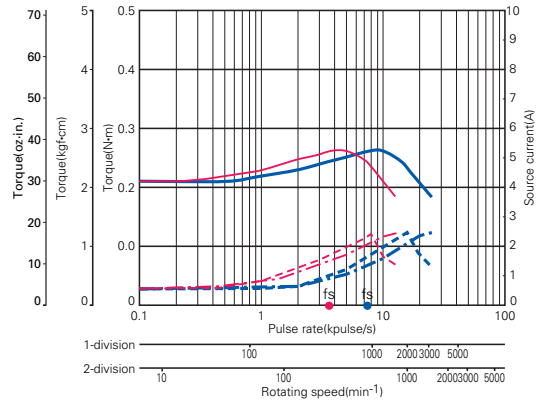

Source voltage:DC36V-Operating current: 0.75A/phase
 — Pull-out torque(J_{L1}=0.94×10⁻⁴kg-m²[5.14 oz-in²]) Use the rubber coupling)
 - - - Source current(T_L=MAX) - - - Source current(T_L=0)
 fs:No load maximum starting pulse rate
 ■ Full step ■ Half step

●103H5510-70 □□:24V

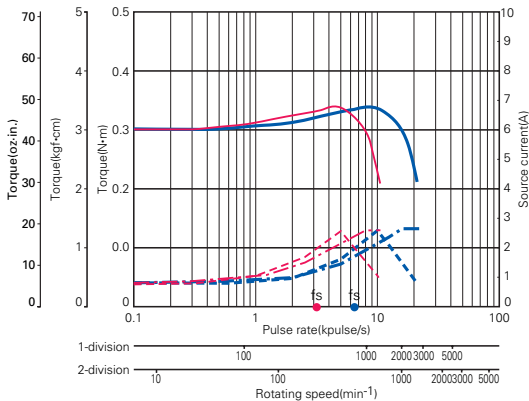

Source voltage:DC24V-Operating current: 0.75A/phase
 — Pull-out torque(J_{L1}=0.94×10⁻⁴kg-m²[5.14 oz-in²]) Use the rubber coupling)
 - - - Source current(T_L=MAX) - - - Source current(T_L=0)
 fs:No load maximum starting pulse rate
 ■ Full step ■ Half step

●103H5510-70 □□:36V

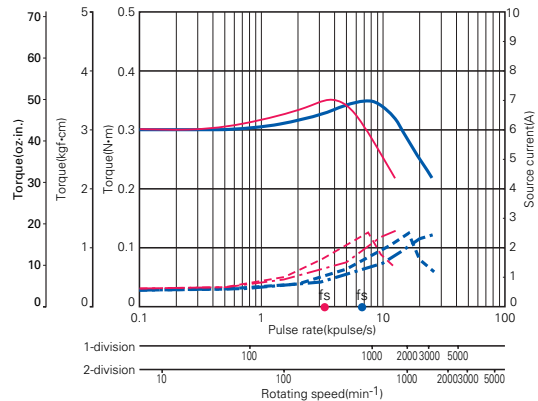

Source voltage:DC36V-Operating current: 0.75A/phase
 — Pull-out torque(J_{L1}=0.94×10⁻⁴kg-m²[5.14 oz-in²]) Use the rubber coupling)
 - - - Source current(T_L=MAX) - - - Source current(T_L=0)
 fs:No load maximum starting pulse rate
 ■ Full step ■ Half step

●103H6500-70 □□:24V

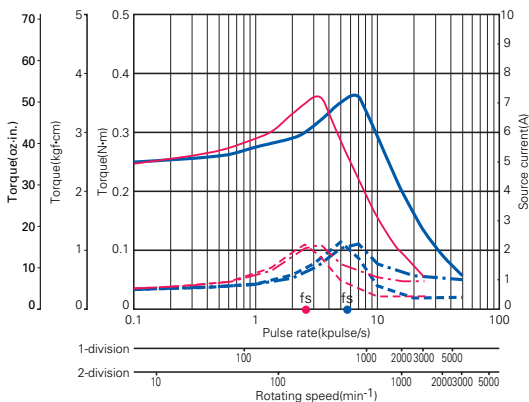

Source voltage:DC24V-Operating current: 0.75A/phase
 — Pull-out torque(J_{L1}=0.94×10⁻⁴kg-m²[5.14 oz-in²]) Use the rubber coupling)
 - - - Source current(T_L=MAX) - - - Source current(T_L=0)
 fs:No load maximum starting pulse rate
 ■ Full step ■ Half step

●103H6500-70 □□:36V

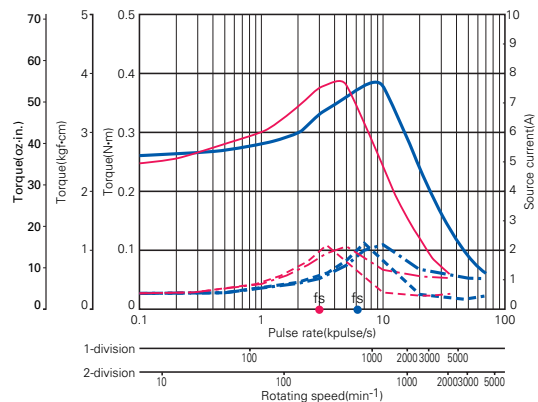

Source voltage:DC36V-Operating current: 0.75A/phase
 — Pull-out torque(J_{L1}=0.94×10⁻⁴kg-m²[5.14 oz-in²]) Use the rubber coupling)
 - - - Source current(T_L=MAX) - - - Source current(T_L=0)
 fs:No load maximum starting pulse rate
 ■ Full step ■ Half step

PMAPA1S6A01

PMAPA1S6B01

PMMA-MA-50034

PMMA-MA-50064

PMMA-BA-5603-5643

PMMA-BA-5604-5644

PMDDPB1S6P01

PMDDPC1S3P01

PMMA-MD-53030-53031

PMMA-BD-53130-53131

PMDDP1S1P01

PMDDPA1C3P50

Pulse rate-torque characteristics/pulse rate-source current characteristics

●103H6501-70 □□ :24V

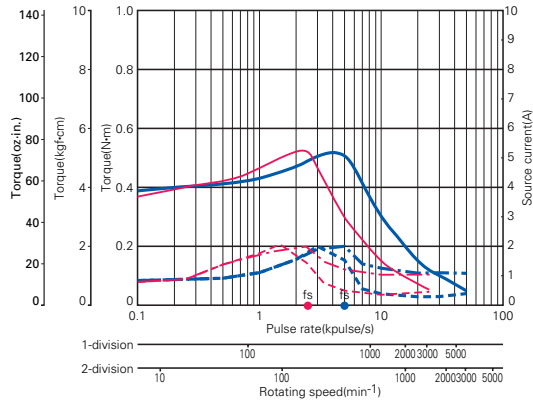

Source voltage:DC24V/Operating current: 0.75A/phase
 — Pull-out torque($J_{L1}=0.94 \times 10^{-4} \text{kg} \cdot \text{m}^2 [5.14 \text{ oz} \cdot \text{in}^2]$ Use the rubber coupling)
 - - - Source current($T_L=\text{MAX}$) - - - Source current($T_L=0$)
 fs:No load maximum starting pulse rate
 ■ Full step ■ Half step

●103H6501-70 □□ :36V

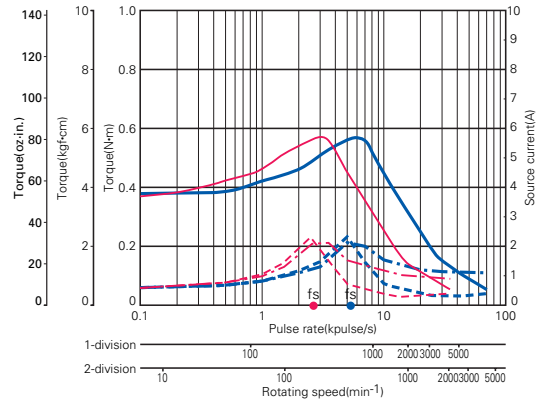

Source voltage:DC36V/Operating current: 0.75A/phase
 — Pull-out torque($J_{L1}=0.94 \times 10^{-4} \text{kg} \cdot \text{m}^2 [5.14 \text{ oz} \cdot \text{in}^2]$ Use the rubber coupling)
 - - - Source current($T_L=\text{MAX}$) - - - Source current($T_L=0$)
 fs:No load maximum starting pulse rate
 ■ Full step ■ Half step

●103H7851-70 □□ :24V

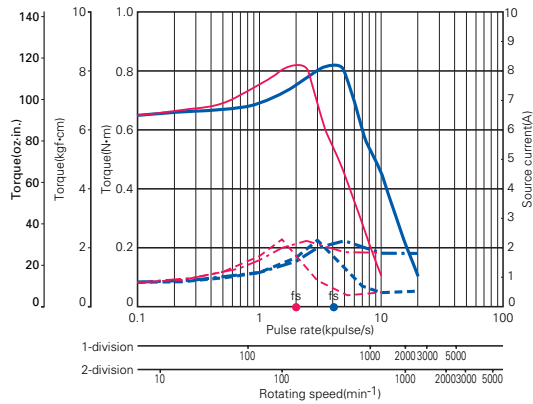

Source voltage:DC24V/Operating current: 0.75A/phase
 — Pull-out torque($J_{L1}=0.94 \times 10^{-4} \text{kg} \cdot \text{m}^2 [5.14 \text{ oz} \cdot \text{in}^2]$ Use the rubber coupling)
 - - - Source current($T_L=\text{MAX}$) - - - Source current($T_L=0$)
 fs:No load maximum starting pulse rate
 ■ Full step ■ Half step

●103H7851-70 □□ :36V

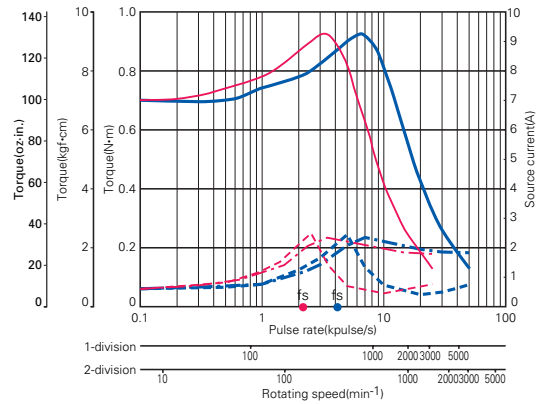

Source voltage:DC36V/Operating current: 0.75A/phase
 — Pull-out torque($J_{L1}=0.94 \times 10^{-4} \text{kg} \cdot \text{m}^2 [5.14 \text{ oz} \cdot \text{in}^2]$ Use the rubber coupling)
 - - - Source current($T_L=\text{MAX}$) - - - Source current($T_L=0$)
 fs:No load maximum starting pulse rate
 ■ Full step ■ Half step

●103H7852-70 □□ :24V

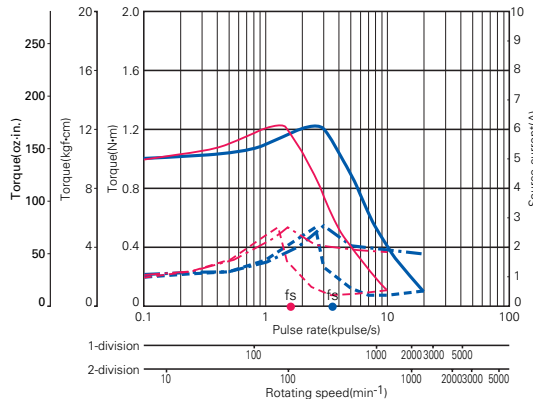

Source voltage:DC24V/Operating current: 0.75A/phase
 — Pull-out torque($J_{L1}=2.6 \times 10^{-4} \text{kg} \cdot \text{m}^2 [14.22 \text{ oz} \cdot \text{in}^2]$ Use the rubber coupling)
 - - - Source current($T_L=\text{MAX}$) - - - Source current($T_L=0$)
 fs:No load maximum starting pulse rate
 ■ Full step ■ Half step

●103H7852-70 □□ :36V

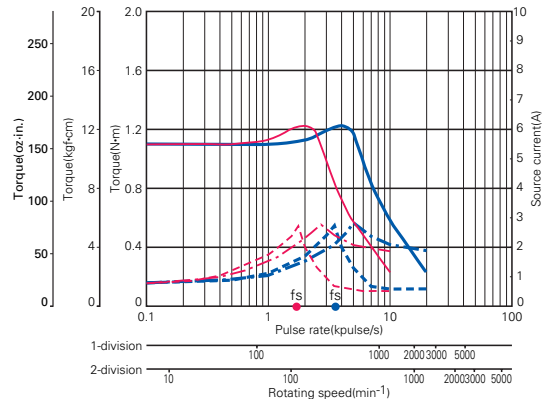

Source voltage:DC36V/Operating current: 0.75A/phase
 — Pull-out torque($J_{L1}=2.6 \times 10^{-4} \text{kg} \cdot \text{m}^2 [14.22 \text{ oz} \cdot \text{in}^2]$ Use the rubber coupling)
 - - - Source current($T_L=\text{MAX}$) - - - Source current($T_L=0$)
 fs:No load maximum starting pulse rate
 ■ Full step ■ Half step

Pulse rate-torque characteristics/pulse rate-source current characteristics

●103H7853-70 □□:24V

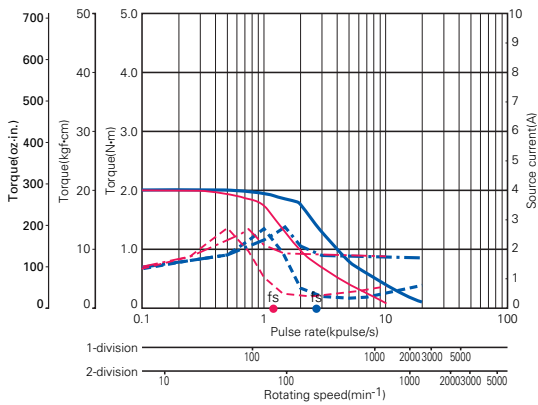

Source voltage:DC24V-Operating current: 0.75A/phase
 — Pull-out torque($J_{L1}=7.4 \times 10^{-4} \text{kg}\cdot\text{m}^2$ [40.46 oz-in²] Use the rubber coupling)
 - - - Source current($T_L=\text{MAX}$) - - - Source current($T_L=0$)
 fs:No load maximum starting pulse rate
 ■ Full step ■ Half step

●103H7853-70 □□:36V

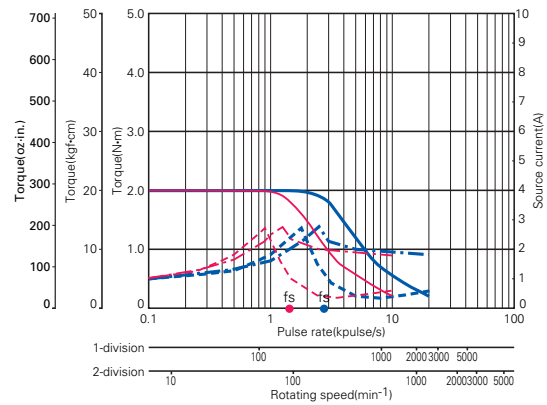

Source voltage:DC36V-Operating current: 0.75A/phase
 — Pull-out torque($J_{L1}=7.4 \times 10^{-4} \text{kg}\cdot\text{m}^2$ [40.46 oz-in²] Use the rubber coupling)
 - - - Source current($T_L=\text{MAX}$) - - - Source current($T_L=0$)
 fs:No load maximum starting pulse rate
 ■ Full step ■ Half step

●103H7521-70 □□:24V

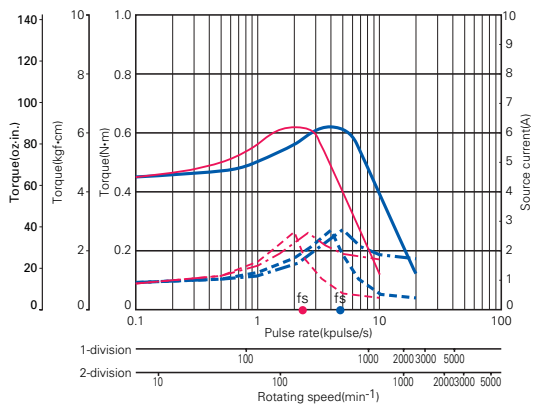

Source voltage:DC24V-Operating current: 0.75A/phase
 — Pull-out torque($J_{L1}=0.94 \times 10^{-4} \text{kg}\cdot\text{m}^2$ [5.14 oz-in²] Use the rubber coupling)
 - - - Source current($T_L=\text{MAX}$) - - - Source current($T_L=0$)
 fs:No load maximum starting pulse rate
 ■ Full step ■ Half step

●103H7521-70 □□:36V

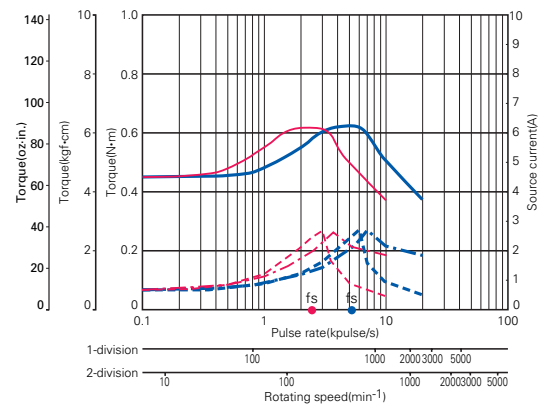

Source voltage:DC36V-Operating current: 0.75A/phase
 — Pull-out torque($J_{L1}=0.94 \times 10^{-4} \text{kg}\cdot\text{m}^2$ [5.14 oz-in²] Use the rubber coupling)
 - - - Source current($T_L=\text{MAX}$) - - - Source current($T_L=0$)
 fs:No load maximum starting pulse rate
 ■ Full step ■ Half step

●103H7522-70 □□:24V

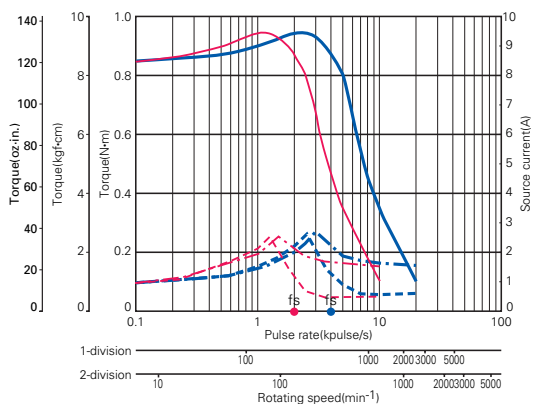

Source voltage:DC24V-Operating current: 0.75A/phase
 — Pull-out torque($J_{L1}=2.6 \times 10^{-4} \text{kg}\cdot\text{m}^2$ [14.22 oz-in²] Use the rubber coupling)
 - - - Source current($T_L=\text{MAX}$) - - - Source current($T_L=0$)
 fs:No load maximum starting pulse rate
 ■ Full step ■ Half step

●103H7522-70 □□:36V

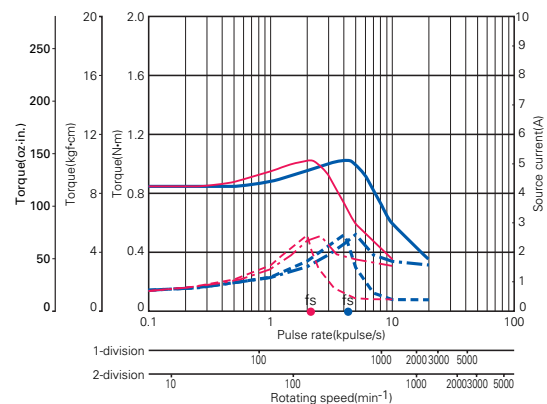

Source voltage:DC36V-Operating current: 0.75A/phase
 — Pull-out torque($J_{L1}=2.6 \times 10^{-4} \text{kg}\cdot\text{m}^2$ [14.22 oz-in²] Use the rubber coupling)
 - - - Source current($T_L=\text{MAX}$) - - - Source current($T_L=0$)
 fs:No load maximum starting pulse rate
 ■ Full step ■ Half step

PMAPA1S6A01

PMAPA1S6B01

PMIM-MA-50034

PMIM-MA-50064

PMIM-BA-5603-5643

PMIM-BA-5604-5644

PMIDPB1S6P01

PMIDPC1S3P01

PMIM-ND-53030-53031

PMIM-BD-53130-53131

PMIDPD1S1P01

PMIDPA1C3P50

Pulse rate-torque characteristics/pulse rate-source current characteristics

●103H7523-70 □□ :24V

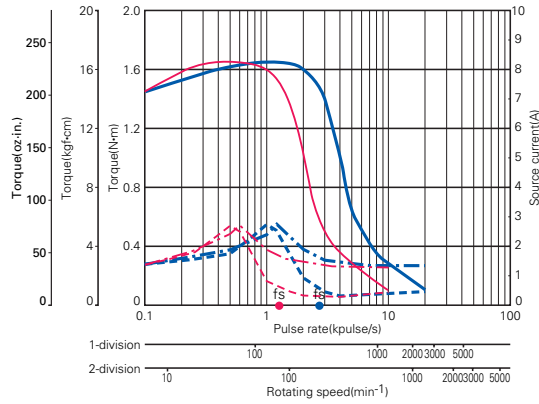

Source voltage:DC24V-Operating current: 0.75A/phase
 — Pull-out torque($J_{L1}=7.4 \times 10^{-4} \text{kg}\cdot\text{m}^2$ [40.46 oz-in²] Use the rubber coupling)
 - - - Source current($T_L=\text{MAX}$) - - - Source current($T_L=0$)
 fs:No load maximum starting pulse rate
 ■ Full step ■ Half step

●103H7523-70 □□ :36V

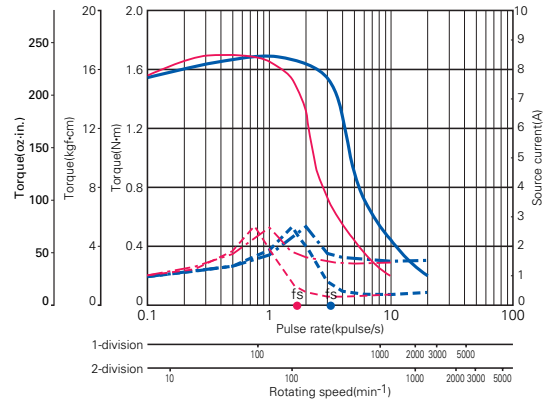

Source voltage:DC36V-Operating current: 0.75A/phase
 — Pull-out torque($J_{L1}=7.4 \times 10^{-4} \text{kg}\cdot\text{m}^2$ [40.46 oz-in²] Use the rubber coupling)
 - - - Source current($T_L=\text{MAX}$) - - - Source current($T_L=0$)
 fs:No load maximum starting pulse rate
 ■ Full step ■ Half step

●103H8581-70 □□ :24V

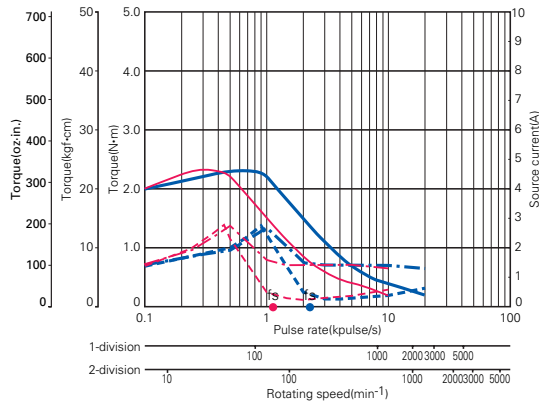

Source voltage:DC24V-Operating current: 0.75A/phase
 — Pull-out torque($J_{L1}=7.4 \times 10^{-4} \text{kg}\cdot\text{m}^2$ [40.46 oz-in²] Use the rubber coupling)
 - - - Source current($T_L=\text{MAX}$) - - - Source current($T_L=0$)
 fs:No load maximum starting pulse rate
 ■ Full step ■ Half step

●103H8581-70 □□ :36V

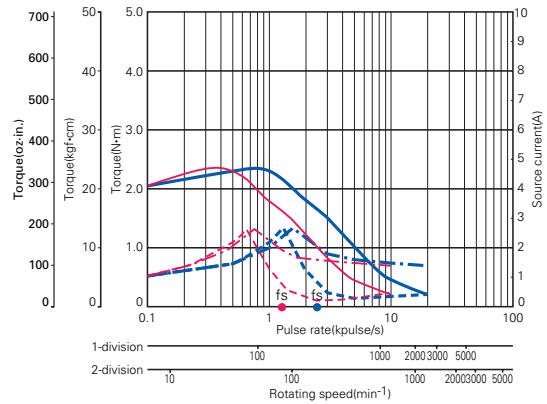

Source voltage:DC36V-Operating current: 0.75A/phase
 — Pull-out torque($J_{L1}=7.4 \times 10^{-4} \text{kg}\cdot\text{m}^2$ [40.46 oz-in²] Use the rubber coupling)
 - - - Source current($T_L=\text{MAX}$) - - - Source current($T_L=0$)
 fs:No load maximum starting pulse rate
 ■ Full step ■ Half step

●103H8582-70 □□ :24V

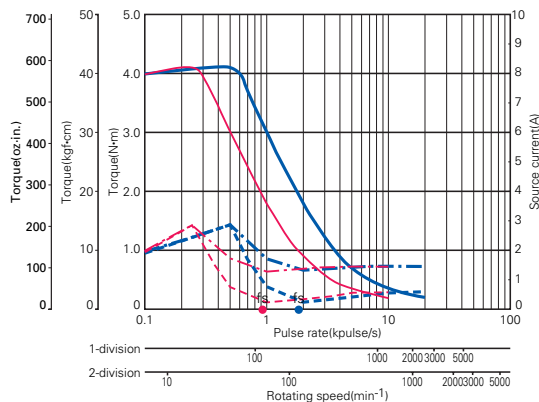

Source voltage:DC24V-Operating current: 0.75A/phase
 — Pull-out torque($J_{L1}=15.3 \times 10^{-4} \text{kg}\cdot\text{m}^2$ [83.65 oz-in²] Use the rubber coupling)
 - - - Source current($T_L=\text{MAX}$) - - - Source current($T_L=0$)
 fs:No load maximum starting pulse rate
 ■ Full step ■ Half step

●103H8582-70 □□ :36V

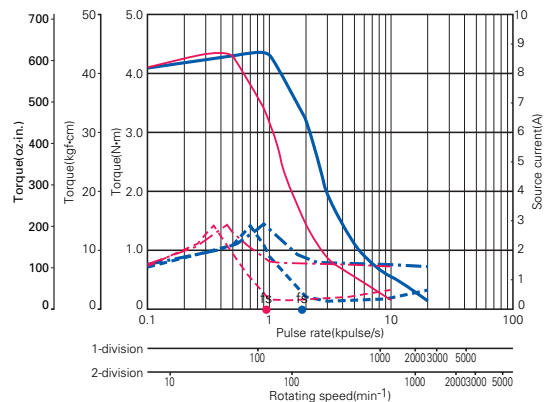

Source voltage:DC36V-Operating current: 0.75A/phase
 — Pull-out torque($J_{L1}=15.3 \times 10^{-4} \text{kg}\cdot\text{m}^2$ [83.65 oz-in²] Use the rubber coupling)
 - - - Source current($T_L=\text{MAX}$) - - - Source current($T_L=0$)
 fs:No load maximum starting pulse rate
 ■ Full step ■ Half step

Pulse rate-torque characteristics/pulse rate-source current characteristics

●103H8583-70 □□:24V

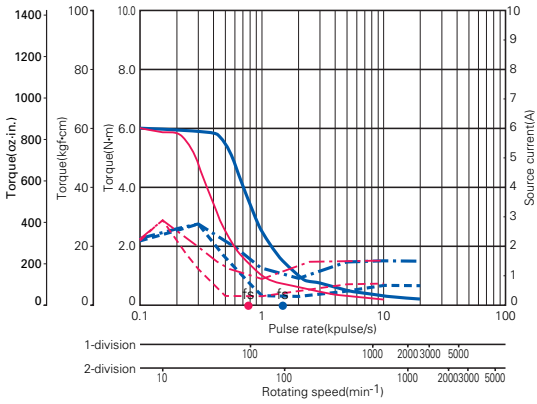

Source voltage:DC24V-Operating current: 0.75A/phase
 — Pull-out torque($J_{L1}=43 \times 10^{-4} \text{kg}\cdot\text{m}^2$ [235.10 oz.in²] Use the rubber coupling)
 - - - Source current($T_L=\text{MAX}$) - - - Source current($T_L=0$)
 fs:No load maximum starting pulse rate
 ■ Full step ■ Half step

●103H8583-70 □□:36V

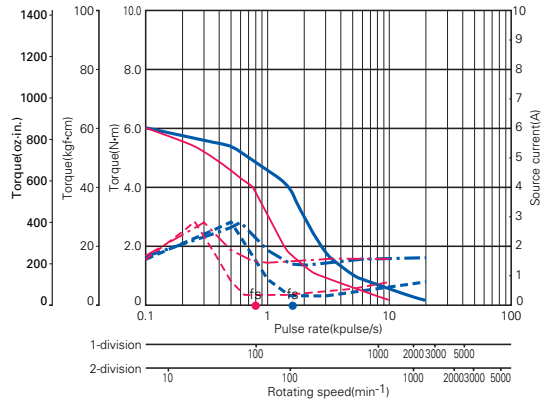

Source voltage:DC36V-Operating current: 0.75A/phase
 — Pull-out torque($J_{L1}=43 \times 10^{-4} \text{kg}\cdot\text{m}^2$ [235.10 oz.in²] Use the rubber coupling)
 - - - Source current($T_L=\text{MAX}$) - - - Source current($T_L=0$)
 fs:No load maximum starting pulse rate
 ■ Full step ■ Half step

PMAPA1S6A01

PMAPA1S6B01

PMIM-MA-50034

PMIM-MA-50064

PMIM-BA-5603-5643

PMIM-BA-5604-5644

PMDPB1S6P01

PMDPC1S3P01

PMIM-MD-53030-53031

PMIM-BD-53130-53131

PMDPD1S1P01

PMDPA1C3P50

Option

PMM-MD-53030-10 (Photo coupler input system)

● Connector set

Model number	Used for	Set content	Quantity	Manufacturer name	Applicable cable size	Crimping tool model number
PM-AP-010	I/O signals (CN1A)	Applicable housing:5051-10	1	Molex Japan	AWG22~28	JHTR2262A JHTR2262J
		Applicable contact:2759PBGL	10			
PM-AP-006	DC power source (CN2)	Applicable housing:5051-04	1	Molex Japan	AWG22~28	JHTR2262A JHTR2262J
		Applicable contact:5159PBTB	4			
PM-AP-045 (Type H785 □□)	Stepping motor (CN3)	Applicable housing:5051-05	1	Molex Japan	AWG22	JHTR2262A
		Applicable contact:5159PBTB	5	J.S.T. Mfg Co., Ltd.		YC-160R
		Applicable housing:VHR-5N	1			
		Applicable contact:SVH-21T-P1.1	5			
PM-AP-046 (Type H35 □□□)	Stepping motor (CN3)	Applicable housing:5051-05	1	Molex Japan	AWG24~28	JHTR2262A JHTR2262J
		Applicable contact:5159PBTB	5	J.S.T. Mfg Co., Ltd.		YRM-240
		Applicable housing:PHR-5	1			
		Applicable contact:SPH-002T-P0.5S	5			
PM-AP-007 (Types other than above)	Stepping motor (CN3)	Applicable housing:5051-05	1	Molex Japan	AWG22~28	JHTR2262A JHTR2262J
		Applicable contact:5159PBTB	5			

● Connector cable

Model number	Application
PM-C10S0100-01	Connector cable for I/O signal (CN1A)
PM-C04P0100-01	Connector cable for DC power source (CN2)
PM-C05M0100-□□	Connector cable for stepping motors (CN3)

- The connector cable is a 1-meter cable assembled with the connector.

□□ is a space to be filled by the serial number 01, 03, or 04 (refer to Supplement table 1).

Stepping motor cable model number (Supplement table 1)

Serial No.	Stepping motor model number
01	103H5505-70 □□
	103H5508-70 □□
	103H5510-70 □□
	103H6500-70 □□
	103H6501-70 □□
	103H7521-70 □□
	103H7522-70 □□
	103H7523-70 □□
	103H8581-70 □□
	103H8582-70 □□
	103H8583-70 □□

Serial No.	Stepping motor model number
03	103H3505-70 □□
	103H3515-70 □□
04	103H7851-70 □□
	103H7852-70 □□
	103H7853-70 □□

Option

PMM-MD-53031-10 (CMOS input system)

● Connector set

Model number	Used for	Set content	Quantity	Manufacturer name	Applicable cable size	Crimping tool model number
PM-AP-011	I/O signal and DC power source (CN1B)	Applicable housing : 5051-12	1	Molex Japan	AWG22~28	JHTR2262A JHTR2262J
		Applicable contact : 2759PBGL	12			
PM-AP-045 (Type H785 □□)	Stepping motor (CN3)	Applicable housing : 5051-05	1	Molex Japan	AWG22	JHTR2262A
		Applicable contact : 5159PBTL	5	J.S.T. Mfg Co., Ltd.		YC-160R
		Applicable housing : VHR-5N	1			
		Applicable contact : SVH-21T-P1.1	5			
PM-AP-046 (Type H35 □)	Stepping motor (CN3)	Applicable housing : 5051-05	1	Molex Japan	AWG24~28	JHTR2262A JHTR2262J
		Applicable contact : 5159PBTL	5	J.S.T. Mfg Co., Ltd.		YRM-240
		Applicable housing : PHR-5	1			
		Applicable contact : SPH-002T-P0.5S	5			
PM-AP-007 (Types other than above)	Stepping motor (CN3)	Applicable housing : 5051-05	1	Molex Japan	AWG22~28	JHTR2262A JHTR2262J
		Applicable contact : 5159PBTL	5			

● Connector cable

Model number	Application
PM-C12T0100-01	Connector cable for I/O signal and DC power source (CN1B)
PM-C05M0100-□□	Connector cable for stepping motors (CN3)

□□ is a space to be filled by the serial number 01, 03, or 04 (refer to Supplement table 1).

- The connector cable is a 1-meter cable assembled with the connector.

Stepping motor cable model number (Supplement table 1)

Serial No.	Stepping motor model number
01	103H5505-70 □□
	103H5508-70 □□
	103H5510-70 □□
	103H6500-70 □□
	103H6501-70 □□
	103H7521-70 □□
	103H7522-70 □□
	103H7523-70 □□
	103H8581-70 □□
	103H8582-70 □□
	103H8583-70 □□

Serial No.	Stepping motor model number
03	103H3505-70 □□
	103H3515-70 □□
04	103H7851-70 □□
	103H7852-70 □□
	103H7853-70 □□

Option

● Cable 1 (power source cable)

Driver side	
Pin number	Color
1	White
2	
3	Black
4	

Cable model number	Length
PM-C04P0100-01	1m

● Cable 2 (power source and I/O signal cable)

Driver side	
Pin number	Color
1	White
2	
3	Black
4	
5	White
6	
7	Blue
8	
9	
10	
11	
12	

Cable model number	Length
PM-C12T0100-01	1m

● Cable 3 (I/O signal cable)

Driver side	
Pin number	Color
1	Blue
2	
3	
4	
5	
6	
7	
8	
9	
10	

Cable model number	Length
PM-C10S0100-01	1m

● Cable 4 (stepping motor extension cable 1)

Driver side	
Pin number	Color
1	Black
2	Red
3	Orange
4	Yellow
5	Blue

Cable model number	Length
PM-C05M0100-01	1m

Applicable stepping motor	
103H5505-70□□	103H7522-70□□
103H5508-70□□	103H7523-70□□
103H5510-70□□	103H8581-70□□
103H6500-70□□	103H8582-70□□
103H6501-70□□	103H8583-70□□
103H7521-70□□	

Option

● Cable 5 (stepping motor extension cable 2)

Driver side	
Pin number	Color
1	Black
2	Red
3	Orange
4	Yellow
5	Blue

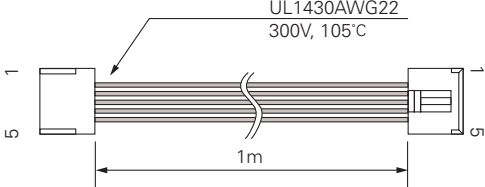

Stepping motor side	
Pin number	Color
1	Black
2	Yellow
3	Orange
4	Red
5	Blue

Cable model number	Length
PM-C05M0100-04	1m

Applicable stepping motor	
103H7851-70□□	
103H7852-70□□	
103H7853-70□□	

● Cable 6 (stepping motor extension cable 3)

Driver side	
Pin number	Color
1	Black
2	Red
3	Orange
4	Yellow
5	Blue

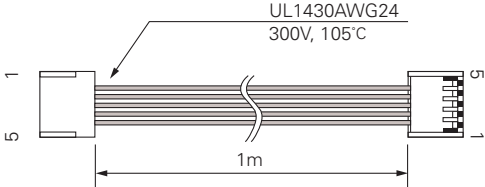

Stepping motor side	
Pin number	Color
1	Blue
2	Orange
3	Red
4	Black
5	Yellow

Cable model number	Length
PM-C05M0100-03	1m

Applicable stepping motor	
103H3505-70□□	
103H3515-70□□	

PMAPAI1S6A01

PMAPAI1S6B01

PMIM-MA-50034

PMIM-MA-50064

PMIM-BA-5603-5643

PMIM-BA-5604-5644

PMIDPB1S6P01

PMIDPC1S3P01

PMIM-MD-53030-53031

PMIM-BD-53130-53131

PMIDPD1S1P01

PMIDPA1C3P50